

ANNEX 22

**RESOLUTION MSC.281(85)
(adopted on 4 December 2008)**

**EXPLANATORY NOTES TO THE SOLAS CHAPTER II-1 SUBDIVISION AND
DAMAGE STABILITY REGULATIONS**

THE MARITIME SAFETY COMMITTEE,

RECALLING Article 28(b) of the Convention on the International Maritime Organization concerning the function of the Committee,

RECALLING ALSO that, by resolution MSC.216(82), it adopted the regulations on subdivision and damage stability as contained in SOLAS chapter II-1 which are based on the probabilistic concept, using the probability of survival after collision as a measure of ships' safety in a damaged condition,

NOTING that, at the eighty-second session, it approved Interim Explanatory Notes to the SOLAS chapter II-1 subdivision and damage stability regulations (MSC.1/Circ.1226), to assist Administrations in the uniform interpretation and application of the aforementioned subdivision and damage stability regulations,

BEING DESIROUS that definitive Explanatory Notes should be adopted when more experience in the application of the the aforementioned subdivision and damage stability regulations and the Interim Explanatory Notes had been gained,

RECOGNIZING that the appropriate application of the Explanatory Notes is essential for ensuring the uniform application of the SOLAS chapter II-1 subdivision and damage stability regulations,

HAVING CONSIDERED, at its eighty-fifth session, the recommendations made by the Sub-Committee on Stability and Load Lines and on Fishing Vessels Safety at its fifty-first session,

1. ADOPTS the Explanatory Notes to the SOLAS chapter II-1 subdivision and damage stability regulations set out in the Annex to the present resolution;
2. URGES Governments and all parties concerned to utilize the Explanatory Notes when applying the SOLAS chapter II-1 subdivision and damage stability regulations adopted by resolution MSC.216(82).

**EXPLANATORY NOTES TO THE SOLAS CHAPTER II-1
SUBDIVISION AND DAMAGE STABILITY REGULATIONS**

Contents

Part A – INTRODUCTION

**Part B – GUIDANCE ON INDIVIDUAL SOLAS CHAPTER II-1 SUBDIVISION AND
DAMAGE STABILITY REGULATIONS**

Regulation 1	Application
Regulation 2	Definitions
Regulation 4	General
Regulation 5	Intact stability information
Regulation 5-1	Stability information to be supplied to the master
Regulation 6	Required subdivision index R
Regulation 7	Attained subdivision index A
Regulation 7-1	Calculation of the factor p_i
Regulation 7-2	Calculation of the factor s_i
Regulation 7-3	Permeability
Regulation 8	Special requirements concerning passenger ship stability
Regulation 8-1	System capabilities after a flooding casualty on passenger ships
Regulation 9	Double bottoms in passenger ships and cargo ships other than tankers
Regulation 10	Construction of watertight bulkheads
Regulation 12	Peak and machinery space bulkheads, shaft tunnels, etc.
Regulation 13	Openings in watertight bulkheads below the bulkhead deck in passenger ships
Regulation 13-1	Openings in watertight bulkheads and internal decks in cargo ships
Regulation 15	Openings in the shell plating below the bulkhead deck of passenger ships and the freeboard deck of cargo ships
Regulation 15-1	External openings in cargo ships
Regulation 16	Construction and initial tests of watertight doors, sidescuttles, etc.
Regulation 17	Internal watertight integrity of passenger ships above the bulkhead deck
Appendix	Guidelines for the preparation of subdivision and damage stability calculations

PART A

INTRODUCTION

1 The harmonized SOLAS regulations on subdivision and damage stability, as contained in SOLAS chapter II-1, are based on a probabilistic concept which uses the probability of survival after collision as a measure of ships' safety in a damaged condition. This probability is referred to as the "attained subdivision index *A*" in the regulations. It can be considered an objective measure of ships' safety and, ideally, there would be no need to supplement this index by any deterministic requirements.

2 The philosophy behind the probabilistic concept is that two different ships with the same attained index are of equal safety and, therefore, there is no need for special treatment of specific parts of the ship, even if they are able to survive different damages. The only areas which are given special attention in the regulations are the forward and bottom regions, which are dealt with by special subdivision rules provided for cases of ramming and grounding.

3 Only a few deterministic elements, which were necessary to make the concept practicable, have been included. It was also necessary to include a deterministic "minor damage" on top of the probabilistic regulations for passenger ships to avoid ships being designed with what might be perceived as unacceptably vulnerable spots in some part of their length.

4 It is easily recognized that there are many factors that will affect the final consequences of hull damage to a ship. These factors are random and their influence is different for ships with different characteristics. For example, it would seem obvious that in ships of similar size carrying different amounts of cargo, damages of similar extents may lead to different results because of differences in the range of permeability and draught during service. The mass and velocity of the ramming ship is obviously another random variable.

5 Due to this, the effect of a three-dimensional damage to a ship with given watertight subdivision depends on the following circumstances:

- .1 which particular space or group of adjacent spaces is flooded;
- .2 the draught, trim and intact metacentric height at the time of damage;
- .3 the permeability of affected spaces at the time of damage;
- .4 the sea state at the time of damage; and
- .5 other factors such as possible heeling moments due to unsymmetrical weights.

6 Some of these circumstances are interdependent and the relationship between them and their effects may vary in different cases. Additionally, the effect of hull strength on penetration will obviously have some effect on the results for a given ship. Since the location and size of the damage is random, it is not possible to state which part of the ship becomes flooded. However, the probability of flooding a given space can be determined if the probability of occurrence of certain damages is known from experience, that is, damage statistics. The probability of flooding a space is then equal to the probability of occurrence of all such damages which just open the considered space to the sea.

7 For these reasons and because of mathematical complexity as well as insufficient data, it would not be practicable to make an exact or direct assessment of their effect on the probability that a particular ship will survive a random damage if it occurs. However, accepting some approximations or qualitative judgments, a logical treatment may be achieved by using the probability approach as the basis for a comparative method for the assessment and regulation of ship safety.

8 It may be demonstrated by means of probability theory that the probability of ship survival should be calculated as the sum of probabilities of its survival after flooding each single compartment, each group of two, three, etc., adjacent compartments multiplied, respectively, by the probabilities of occurrence of such damages leading to the flooding of the corresponding compartment or group of compartments.

9 If the probability of occurrence for each of the damage scenarios the ship could be subjected to is calculated and then combined with the probability of surviving each of these damages with the ship loaded in the most probable loading conditions, we can determine the attained index *A* as a measure for the ship's ability to sustain a collision damage.

10 It follows that the probability that a ship will remain afloat without sinking or capsizing as a result of an arbitrary collision in a given longitudinal position can be broken down to:

- .1 the probability that the longitudinal centre of damage occurs in just the region of the ship under consideration;
- .2 the probability that this damage has a longitudinal extent that only includes spaces between the transverse watertight bulkheads found in this region;
- .3 the probability that the damage has a vertical extent that will flood only the spaces below a given horizontal boundary, such as a watertight deck;
- .4 the probability that the damage has a transverse penetration not greater than the distance to a given longitudinal boundary; and
- .5 the probability that the watertight integrity and the stability throughout the flooding sequence is sufficient to avoid capsizing or sinking.

11 The first three of these factors are solely dependent on the watertight arrangement of the ship, while the last two depend on the ship's shape. The last factor also depends on the actual loading condition. By grouping these probabilities, calculations of the probability of survival, or attained index *A*, have been formulated to include the following probabilities:

- .1 the probability of flooding each single compartment and each possible group of two or more adjacent compartments; and
- .2 the probability that the stability after flooding a compartment or a group of two or more adjacent compartments will be sufficient to prevent capsizing or dangerous heeling due to loss of stability or to heeling moments in intermediate or final stages of flooding.

12 This concept allows a rule requirement to be applied by requiring a minimum value of A for a particular ship. This minimum value is referred to as the “required subdivision index R ” in the present regulations and can be made dependent on ship size, number of passengers or other factors legislators might consider important.

13 Evidence of compliance with the rules then simply becomes:

$$A \geq R$$

13.1 As explained above, the attained subdivision index A is determined by a formula for the entire probability as the sum of the products for each compartment or group of compartments of the probability that a space is flooded, multiplied by the probability that the ship will not capsize or sink due to flooding of the considered space. In other words, the general formula for the attained index can be given in the form:

$$A = \sum p_i s_i$$

13.2 Subscript “ i ” represents the damage zone (group of compartments) under consideration within the watertight subdivision of the ship. The subdivision is viewed in the longitudinal direction, starting with the aftmost zone/compartment.

13.3 The value of “ p_i ” represents the probability that only the zone “ i ” under consideration will be flooded, disregarding any horizontal subdivision, but taking transverse subdivision into account. Longitudinal subdivision within the zone will result in additional flooding scenarios, each with its own probability of occurrence.

13.4 The value of “ s_i ” represents the probability of survival after flooding the zone “ i ” under consideration.

14 Although the ideas outlined above are very simple, their practical application in an exact manner would give rise to several difficulties if a mathematically perfect method was to be developed. As pointed out above, an extensive but still incomplete description of the damage will include its longitudinal and vertical location as well as its longitudinal, vertical and transverse extent. Apart from the difficulties in handling such a five-dimensional random variable, it is impossible to determine its probability distribution very accurately with the presently available damage statistics. Similar limitations are true for the variables and physical relationships involved in the calculation of the probability that a ship will not capsize or sink during intermediate stages or in the final stage of flooding.

15 A close approximation of the available statistics would result in extremely numerous and complicated computations. In order to make the concept practicable, extensive simplifications are necessary. Although it is not possible to calculate the exact probability of survival on such a simplified basis, it has still been possible to develop a useful comparative measure of the merits of the longitudinal, transverse and horizontal subdivision of a ship.

PART B

GUIDANCE ON INDIVIDUAL SOLAS CHAPTER II-1 SUBDIVISION AND DAMAGE STABILITY REGULATIONS

REGULATION 1 – APPLICATION

Regulation 1.3

If a passenger ship built before 1 January 2009 undergoes alterations or modifications of major character, it may still remain under the damage stability regulations applicable to ships built before 1 January 2009, except in the case of a cargo ship being converted to a passenger ship.

REGULATION 2 – DEFINITIONS

Regulation 2.1

Subdivision length (L_s) – Different examples of L_s showing the buoyant hull and the reserve buoyancy are provided in the figures below. The limiting deck for the reserve buoyancy may be partially watertight.

The maximum possible vertical extent of damage above the baseline is $d_s + 12.5$ metres.

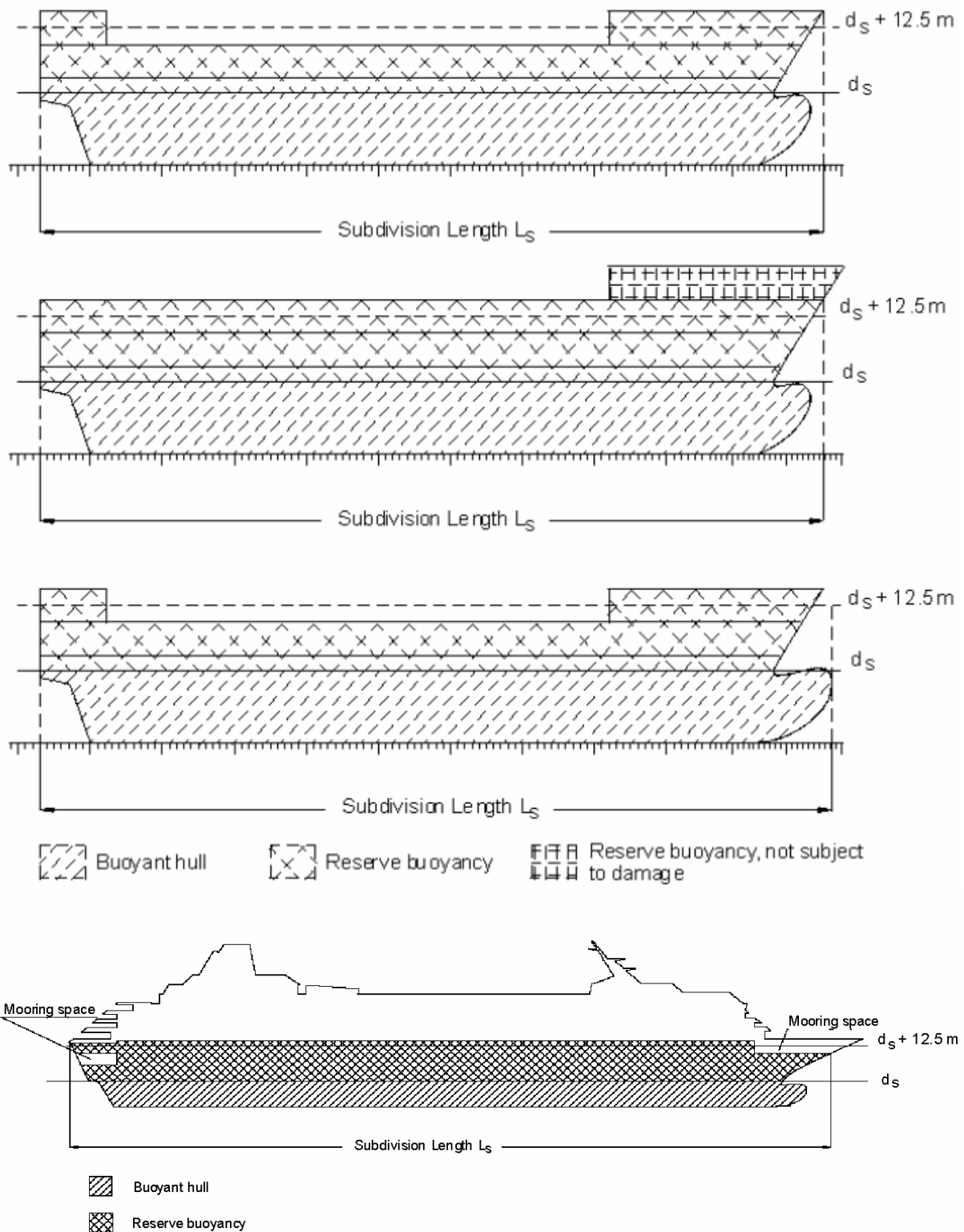

Regulation 2.6

Freeboard deck – See Explanatory Notes for regulation 13-1* for the treatment of a stepped freeboard deck with regard to watertightness and construction requirements.

* References to regulations in these Guidelines are to regulations of SOLAS chapter II-1, unless expressly provided otherwise.

Regulation 2.11

Light service draught (d_l) – The light service draught (d_l) represents the lower draught limit of the minimum required GM (or maximum allowable KG) curve. It corresponds, in general, to the ballast arrival condition with 10% consumables for cargo ships. For passenger ships, it corresponds, in general, to the arrival condition with 10% consumables, a full complement of passengers and crew and their effects, and ballast as necessary for stability and trim. The 10% arrival condition is not necessarily the specific condition that should be used for all ships, but represents, in general, a suitable lower limit for all loading conditions. This is understood to not include docking conditions or other non-voyage conditions.

Regulation 2.19

Bulkhead deck – See Explanatory Notes for regulation 13 for the treatment of a stepped bulkhead deck with regard to watertightness and construction requirements.

REGULATION 4 – GENERAL

Regulation 4.1

Cargo ships complying with the subdivision and damage stability regulations of other IMO instruments listed in the footnote are not required to comply with part B-1, regulations 6, 7, 7-1, 7-2 and 7-3, but should comply with the regulations indicated in the table below.

Regulation	Applies
Part B-1	
5	X
5-1	X
Part B-2	
9	X ⁽¹⁾
10	X
11	X
12	X
13-1	X
15	X
15-1	X
16	X
16-1	X
Part B-4	
19	X
22	X
24	X
25	X ⁽²⁾

(1) Only applies to cargo ships other than tankers.

(2) Only applies to single hold cargo ships other than bulk carriers.

Regulation 4.1, footnote .1

“OBO ships” means *combination carriers* as defined in SOLAS regulation II-2/3.14.

Regulation 4.4

See Explanatory Notes for regulation 7-2.2, for information and guidance related to these provisions.

REGULATION 5 – INTACT STABILITY INFORMATION

Reference is made to MSC/Circ.1158 (Unified interpretation of SOLAS chapter II-1) regarding lightweight check.

REGULATION 5-1 – STABILITY INFORMATION TO BE SUPPLIED TO THE MASTER

Regulation 5-1.2

Any limiting *GM* (or *KG*) requirements arising from provisions in regulation 6.1 (regarding partial attained subdivision indices), regulation 8 or regulation 9, which are in addition to those described in regulation 5-1.4, should also be taken into account when developing this information.

Regulations 5-1.3 and 5-1.4 (see also regulation 7.2)

1 Linear interpolation of the limiting values between the draughts d_s , d_p and d_l is only applicable to minimum *GM* values. If it is intended to develop curves of maximum permissible *KG*, a sufficient number of KM_T values for intermediate draughts should be calculated to ensure that the resulting maximum *KG* curves correspond with a linear variation of *GM*. When light service draught is not with the same trim as other draughts, KM_T for draughts between partial and light service draught should be calculated for trims interpolated between trim at partial draught and trim at light service draught.

2 In cases where the operational trim range is intended to exceed $\pm 0.5\%$ of L_s , the original *GM* limit line should be designed in the usual manner with the deepest subdivision draught and partial subdivision draught calculated at level trim and actual service trim used for the light service draught. Then additional sets of *GM* limit lines should be constructed on the basis of the operational range of trims which is covered by loading conditions of partial subdivision draught and deepest subdivision draught ensuring that intervals of $1\% L_s$ are not exceeded. For the light service draught d_l only one trim should be considered. The sets of *GM* limit lines are combined to give one envelope limiting *GM* curve. The effective trim range of the curve should be clearly stated.

REGULATION 6 – REQUIRED SUBDIVISION INDEX R

Regulation 6.1

To demonstrate compliance with these provisions, see the Guidelines for the preparation of subdivision and damage stability calculations, set out in the appendix, regarding the presentation of damage stability calculation results.

Regulation 6.2.4

Regarding the term “reduced degree of hazard”, the following interpretation should be applied: A lesser value of N , but in no case less than $N = N_1 + N_2$, may be allowed at the discretion of the Administration for passenger ships, which, in the course of their voyages, do not proceed more than 20 miles from the nearest land.

REGULATION 7 – ATTAINED SUBDIVISION INDEX A

Regulation 7.1

1 The probability of surviving after collision damage to the ship’s hull is expressed by the index A . Producing an index A requires calculation of various damage scenarios defined by the extent of damage and the initial loading conditions of the ship before damage. Three loading conditions should be considered and the result weighted as follows:

$$A = 0.4A_s + 0.4A_p + 0.2A_l$$

where the indices s , p and l represent the three loading conditions and the factor to be multiplied to the index indicates how the index A from each loading condition is weighted.

2 The method of calculating A for a loading condition is expressed by the formula:

$$A_c = \sum_{i=1}^{i=t} p_i [v_i s_i]$$

2.1 The index c represents one of the three loading conditions, the index i represents each investigated damage or group of damages and t is the number of damages to be investigated to calculate A_c for the particular loading condition.

2.2 To obtain a maximum index A for a given subdivision, t has to be equal to T , the total number of damages.

3 In practice, the damage combinations to be considered are limited either by significantly reduced contributions to A (i.e. flooding of substantially larger volumes) or by exceeding the maximum possible damage length.

4 The index A is divided into partial factors as follows:

- p_i The p factor is solely dependent on the geometry of the watertight arrangement of the ship.
- v_i The v factor is dependent on the geometry of the watertight arrangement (decks) of the ship and the draught of the initial loading condition. It represents the probability that the spaces above the horizontal subdivision will not be flooded.
- s_i The s factor is dependent on the calculated survivability of the ship after the considered damage for a specific initial condition.

5 Three initial loading conditions should be used for calculating the index A . The loading conditions are defined by their mean draught d , trim and GM (or KG). The mean draught and trim are illustrated in the figure below.

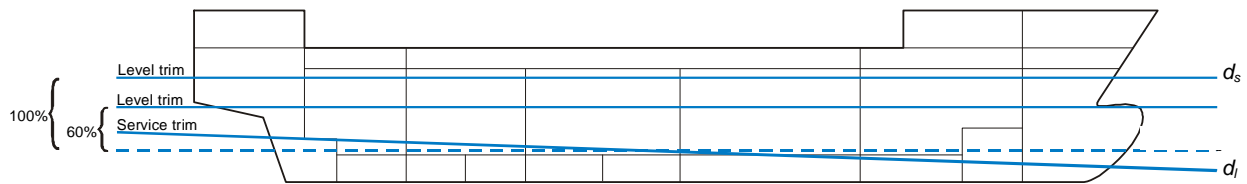

6 The GM (or KG) values for the three loading conditions could, as a first attempt, be taken from the intact stability GM (or KG) limit curve. If the required index R is not obtained, the GM (or KG) values may be increased (or reduced), implying that the intact loading conditions from the intact stability book must now meet the GM (or KG) limit curve from the damage stability calculations derived by linear interpolation between the three GM s.

Regulation 7.2

1 The calculations for differing trim should be carried out with the same initial trim for the partial and deepest subdivision draughts. For the light service draught, the actual service trim should be used (refer to the Explanatory Notes for regulation 2.11).

2 Each combination of the index within the formula given in regulation 7.1 should not be less than the requirement given in regulation 6.2. Each partial index A should comply with the requirements of regulation 6.1.

3 Example:

Based on the GM limiting curves obtained from damage stability calculations of each trim, an envelope curve covering all calculated trim values should be developed.

Calculations covering different trim values should be carried out in steps not exceeding 1% of L_s . The whole range including intermediate trims should be covered by the damage stability calculations. Refer to the example showing an envelope curve obtained from calculations of 0 trim and 1% of L_s .

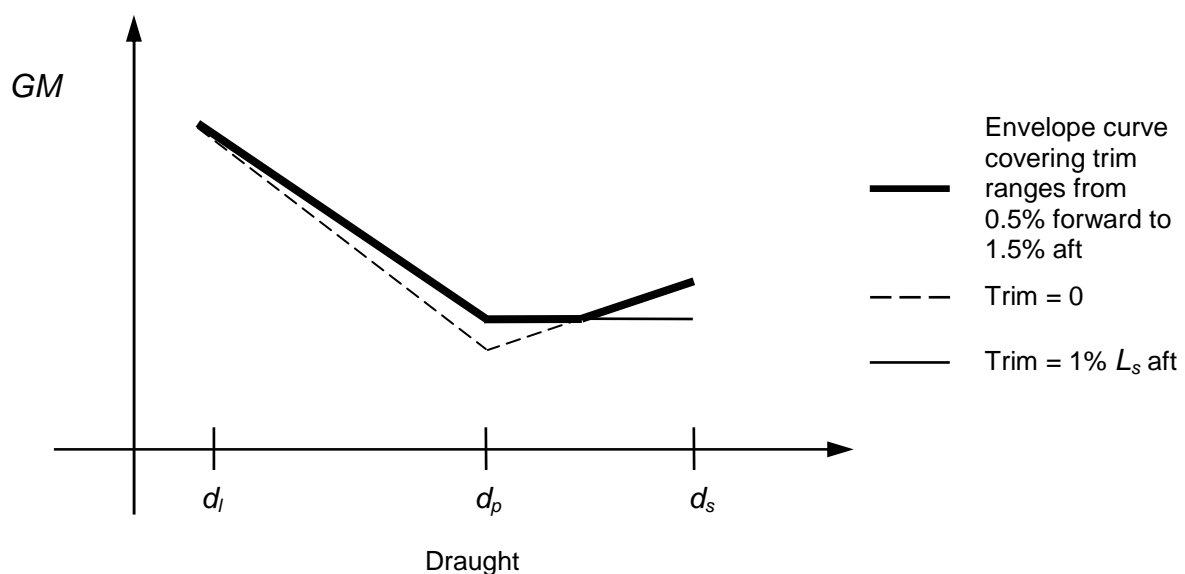

Regulation 7.5

1 With the same intent as wing tanks, the summation of the attained index A should reflect effects caused by all watertight bulkheads and flooding boundaries within the damaged zone. It is not correct to assume damage only to the centreline and ignore changes in subdivision that would reflect lesser contributions.

2 In the forward and aft ends of the ship where the sectional breadth is less than the ship's breadth B , transverse damage penetration can extend beyond the centreline bulkhead. This application of the transverse extent of damage is consistent with the methodology to account for the localized statistics which are normalized on the greatest moulded breadth B rather than the local breadth.

3 Where longitudinal corrugated bulkheads are fitted in wing compartments or on the centreline, they may be treated as equivalent plane bulkheads provided the corrugation depth is of the same order as the stiffening structure. The same principle may also be applied to transverse corrugated bulkheads.

Regulation 7.7

1 Pipes and valves directly adjacent to a bulkhead or to a deck can be considered to be part of the bulkhead or deck, provided the separation distance is of the same order as the bulkhead or deck stiffening structure. The same applies for small recesses, drain wells, etc.

2 The provision for allowing "minor progressive flooding" should be limited to pipes penetrating a watertight subdivision with a total cross-sectional area of not more than 710 mm^2 between any two watertight compartments.

REGULATION 7-1 – CALCULATION OF THE FACTOR p_i

General

1 The definitions below are intended to be used for the application of part B-1 only.

2 In regulation 7-1, the words "compartment" and "group of compartments" should be understood to mean "zone" and "adjacent zones".

3 Zone – a longitudinal interval of the ship within the subdivision length.

4 Room – a part of the ship, limited by bulkheads and decks, having a specific permeability.

5 Space – a combination of rooms.

6 Compartment – an onboard space within watertight boundaries.

7 Damage – the three dimensional extent of the breach in the ship.

8 For the calculation of p , v , r and b only the damage should be considered, for the calculation of the s -value the flooded space should be considered. The figures below illustrate the difference.

Damage shown as the bold square:

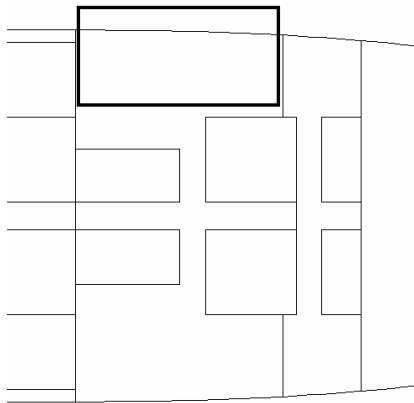

Flooded space shown below:

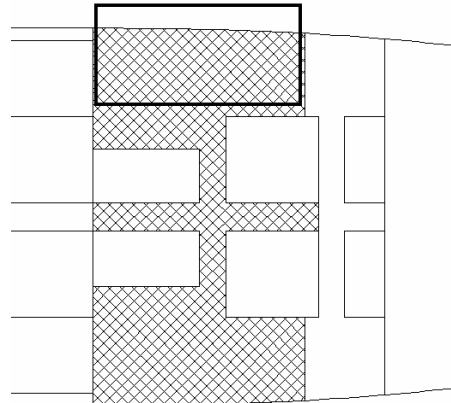

Regulation 7-1.1.1

1 The coefficients b_{11} , b_{12} , b_{21} and b_{22} are coefficients in the bi-linear probability density function on normalized damage length (J). The coefficient b_{12} is dependent on whether L_s is greater or less than L^* (i.e. 260 m); the other coefficients are valid irrespective of L_s .

Longitudinal subdivision

2 In order to prepare for the calculation of index A , the ship's subdivision length L_s is divided into a fixed discrete number of damage zones. These damage zones will determine the damage stability investigation in the way of specific damages to be calculated.

3 There are no rules for the subdividing, except that the length L_s defines the extremes for the actual hull. Zone boundaries need not coincide with physical watertight boundaries. However, it is important to consider a strategy carefully to obtain a good result (that is a large attained index A). All zones and combination of adjacent zones may contribute to the index A . In general it is expected that the more zone boundaries the ship is divided into the higher will be the attained index, but this benefit should be balanced against extra computing time. The figure below shows different longitudinal zone divisions of the length L_s .

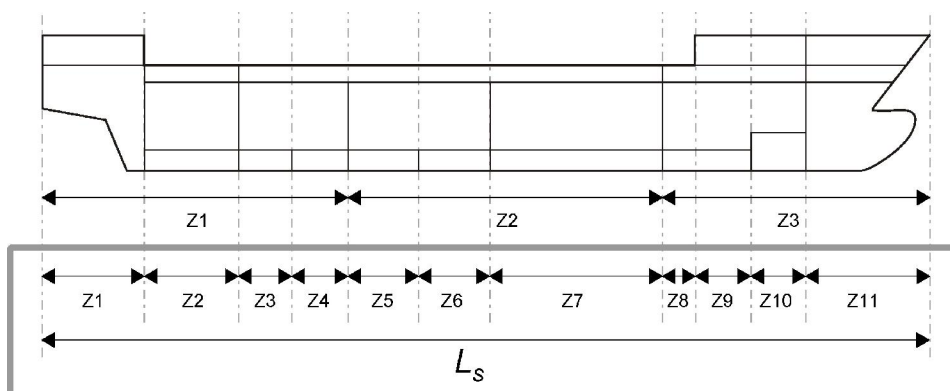

4 The first example is a very rough division into three zones of approximately the same size with limits where longitudinal subdivision is established. The probability that the ship will

survive a damage in one of the three zones is expected to be low (i.e. the s -factor is low or zero) and, therefore, the total attained index A will be correspondingly low.

5 In the second example the zones have been placed in accordance with the watertight arrangement, including minor subdivision (as in double bottom, etc.). In this case there is a much better chance of obtaining higher s -factors.

6 Where transverse corrugated bulkheads are fitted, they may be treated as equivalent plane bulkheads, provided the corrugation depth is of the same order as the stiffening structure.

7 Pipes and valves directly adjacent to a transverse bulkhead can be considered to be part of the bulkhead, provided the separation distance is of the same order as the bulkhead stiffening structure. The same applies for small recesses, drain wells, etc.

8 For cases where the pipes and valves are outside the transverse bulkhead stiffening structure, when they present a risk of progressive flooding to other watertight compartments that will have influence on the overall attained index A , they should be handled either by introducing a new damage zone and accounting for the progressive flooding to associated compartments or by introducing a gap.

9 The triangle in the figure below illustrates the possible single and multiple zone damages in a ship with a watertight arrangement suitable for a seven-zone division. The triangles at the bottom line indicate single zone damages and the parallelograms indicate adjacent zones damages.

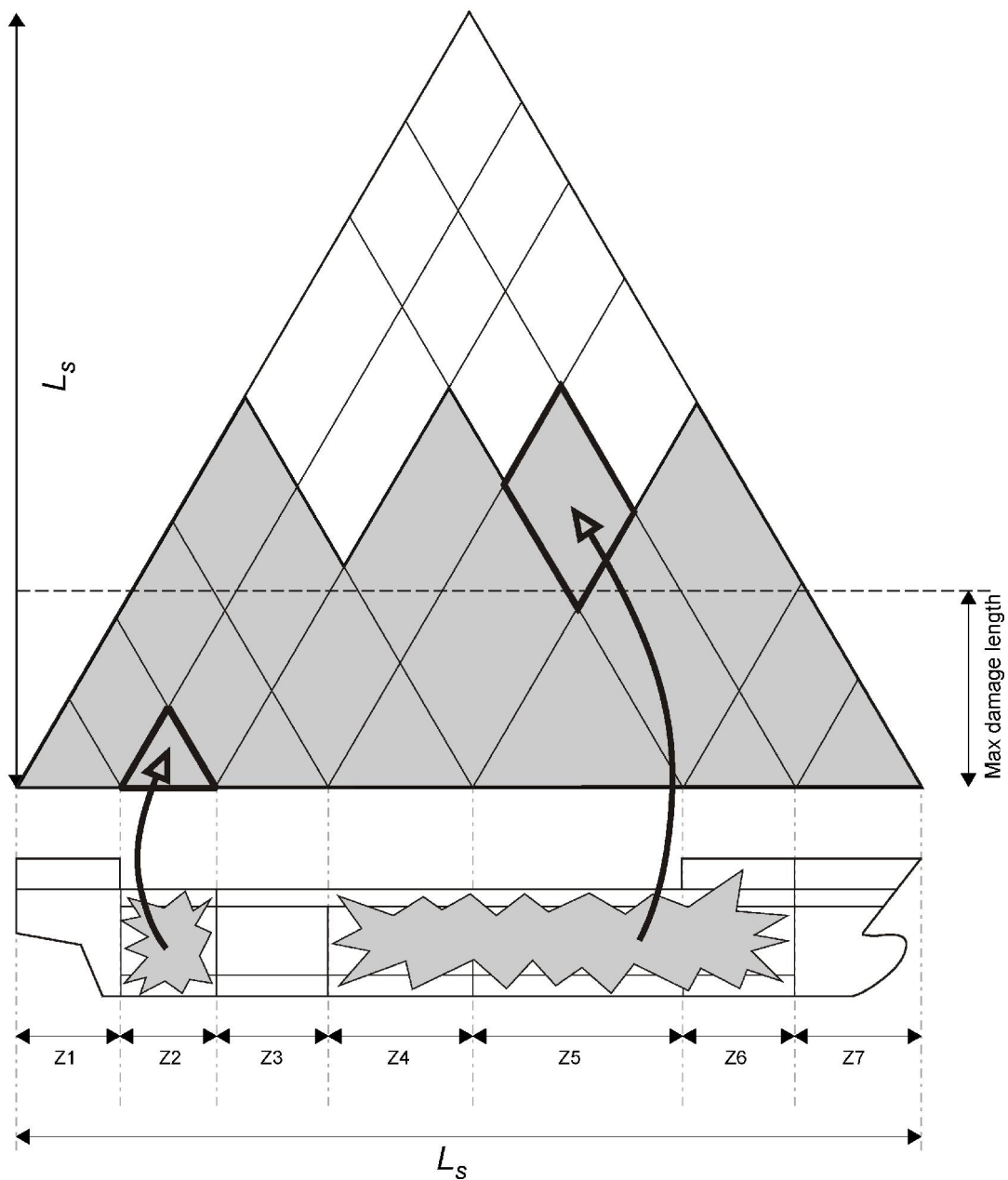

10 As an example, the triangle illustrates a damage opening the rooms in zone 2 to the sea and the parallelogram illustrates a damage where rooms in the zones 4, 5 and 6 are flooded simultaneously.

11 The shaded area illustrates the effect of the maximum absolute damage length. The p -factor for a combination of three or more adjacent zones equals zero if the length of the combined adjacent damage zones minus the length of the foremost and the aft most damage zones in the combined damage zone is greater than the maximum damage length. Having this in mind when subdividing L_s could limit the number of zones defined to maximize the attained index A .

12 As the p -factor is related to the watertight arrangement by the longitudinal limits of damage zones and the transverse distance from the ship side to any longitudinal barrier in the zone, the following indices are introduced:

- j : the damage zone number starting with No.1 at the stern;
- n : the number of adjacent damage zones in question where j is the aft zone;
- k : the number of a particular longitudinal bulkhead as a barrier for transverse penetration in a damage zone counted from shell towards the centreline. The shell has No.0;
- K : total number of transverse penetration boundaries;
- $p_{j,n,k}$: the p -factor for a damage in zone j and next $(n-1)$ zones forward of j damaged to the longitudinal bulkhead k .

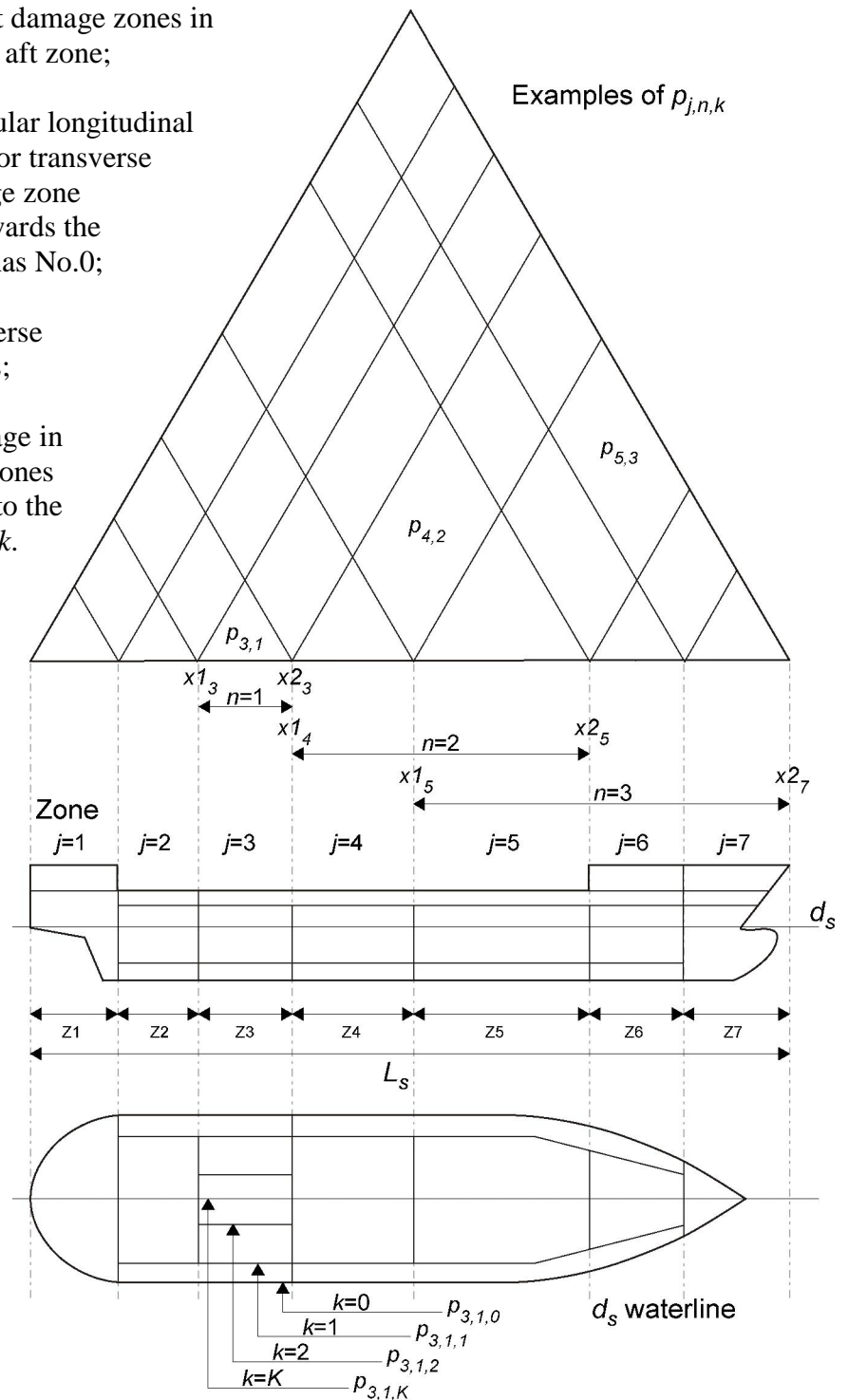

Pure longitudinal subdivision

Single damage zone, pure longitudinal subdivision:

$$p_{j,1} = p(x1_j, x2_j)$$

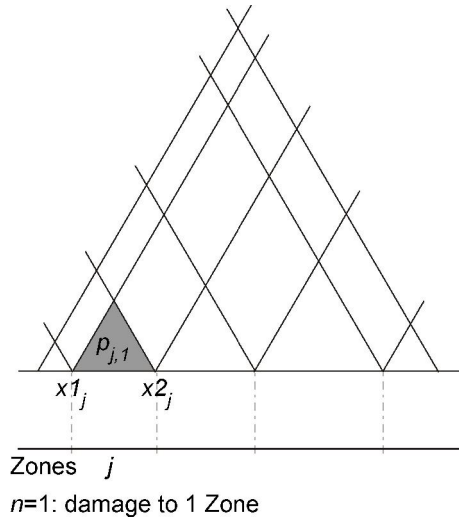

Two adjacent zones, pure longitudinal subdivision:

$$p_{j,2} = p(x1_j, x2_{j+1}) - p(x1_j, x2_j) - p(x1_{j+1}, x2_{j+1})$$

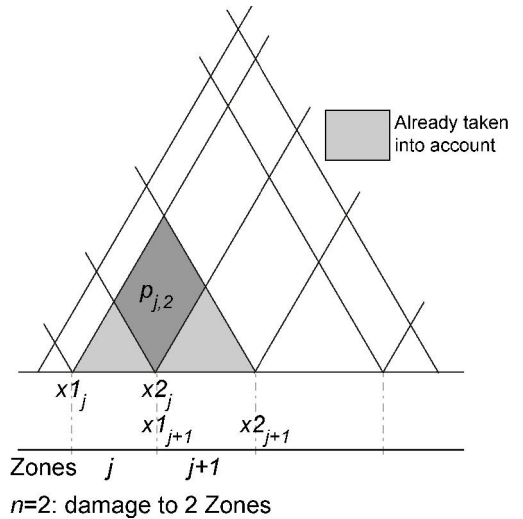

Three or more adjacent zones, pure longitudinal subdivision:

$$p_{j,n} = p(x1_j, x2_{j+n-1}) - p(x1_j, x2_{j+n-2}) - p(x1_{j+1}, x2_{j+n-1}) + p(x1_{j+1}, x2_{j+n-2})$$

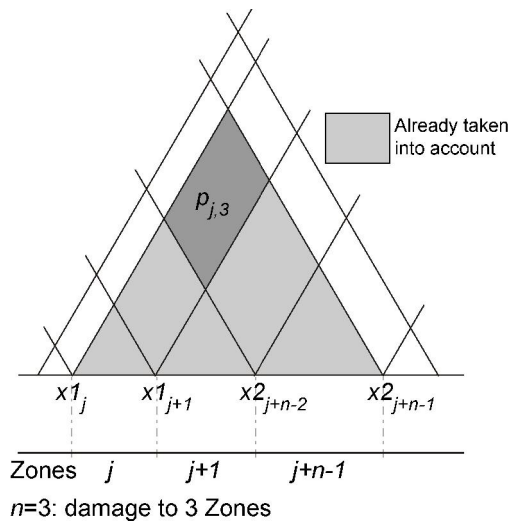

Regulation 7-1.1.2***Transverse subdivision in a damage zone***

1 Damage to the hull in a specific damage zone may just penetrate the ship's watertight hull or penetrate further towards the centreline. To describe the probability of penetrating only a wing compartment, a probability factor r is used, based mainly on the penetration depth b . The value of r is equal to 1, if the penetration depth is $B/2$ where B is the maximum breadth of the ship at the deepest subdivision draught d_s , and $r = 0$ if $b = 0$.

2 The penetration depth b is measured at level deepest subdivision draught d_s as a transverse distance from the ship side right-angled to the centreline to a longitudinal barrier.

3 Where the actual watertight bulkhead is not a plane parallel to the shell, b should be determined by means of an assumed line, dividing the zone to the shell in a relationship b_1/b_2 with $1/2 \leq b_1/b_2 \leq 2$.

4 Examples of such assumed division lines are illustrated in the figure below. Each sketch represents a single damage zone at a water line plane level d_s and the longitudinal bulkhead represents the outermost bulkhead position below $d_s + 12.5$ m.

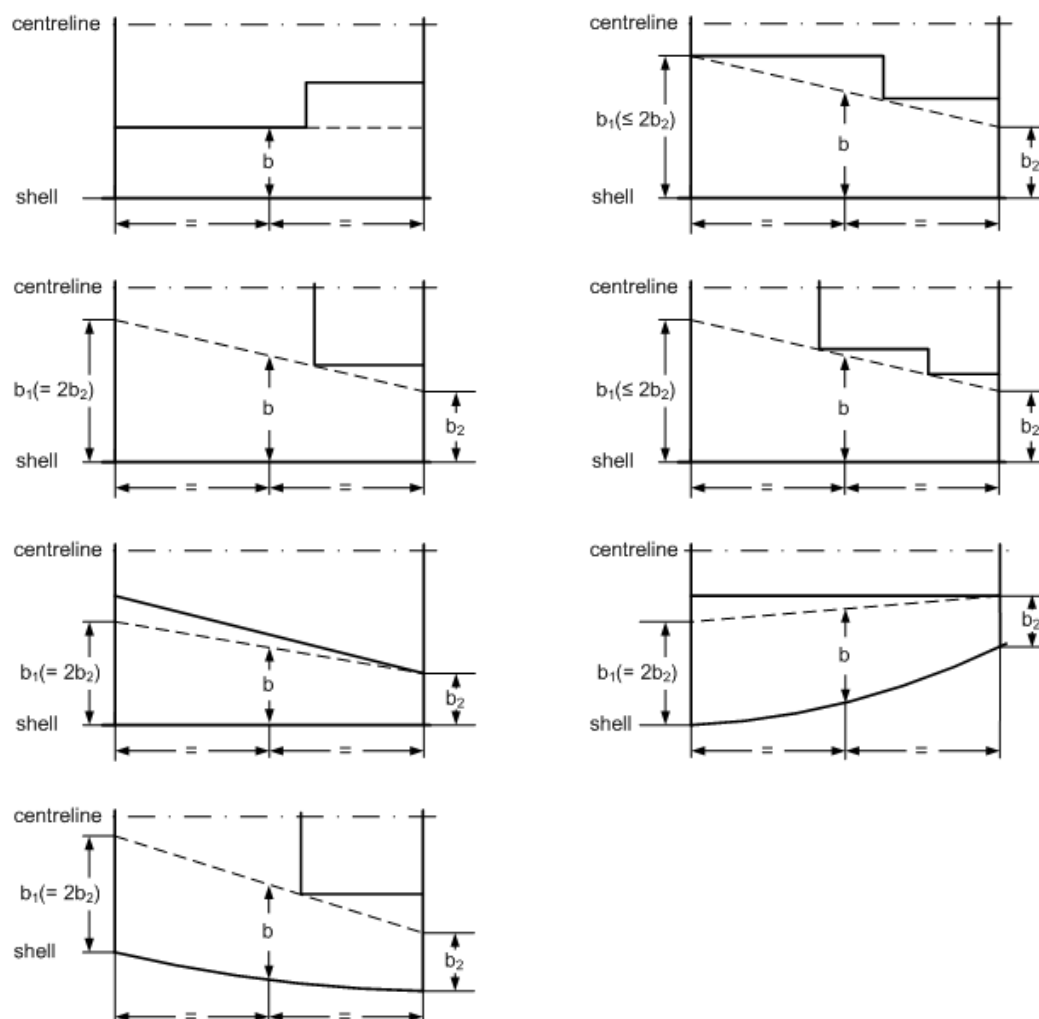

5 In calculating r -values for a group of two or more adjacent compartments, the b -value is common for all compartments in that group, and equal to the smallest b -value in that group:

$$b = \min\{b_1, b_2, K, b_n\}$$

where: $n =$ number of wing compartments in that group;
 $b_1, b_2, K, b_n =$ mean values of b for individual wing compartments contained in the group.

Accumulating p

6 The accumulated value of p for one zone or a group of adjacent zones is determined by:

$$P_{j,n} = \sum_{k=1}^{k=K_{j,n}} p_{j,n,k}$$

where $K_{j,n} = \sum_j^{j+n-1} K_j$ the total number of b_k 's for the adjacent zones in question.

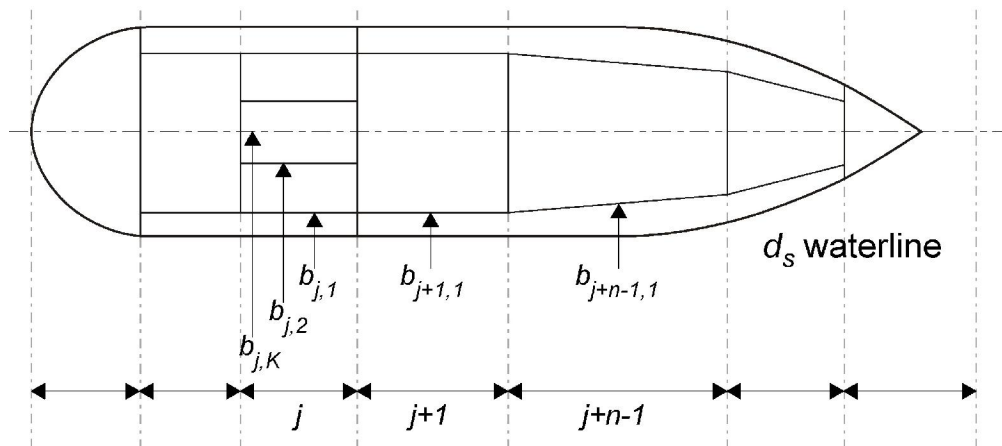

7 The figure above illustrates b 's for adjacent zones. The zone j has two penetration limits and one to the centre, the zone $j+1$ has one b and the zone $j+n-1$ has one value for b . The multiple zones will have $(2+1+1)$ four values of b , and sorted in increasing order they are:

$$(b_{j,1}; b_{j+1,1}; b_{j+n-1,1}; b_{j,2}; b_K)$$

8 Because of the expression for $r(x1, x2, b)$ only one b_K should be considered. To minimize the number of calculations, b 's of the same value may be deleted.

$$\text{As } b_{j,1} = b_{j+1,1} \text{ the final } b\text{'s will be } (b_{j,1}; b_{j+n-1,1}; b_{j,2}; b_K)$$

Examples of multiple zones having a different b

9 Examples of combined damage zones and damage definitions are given in the figures below. Compartments are identified by R10, R12, etc.

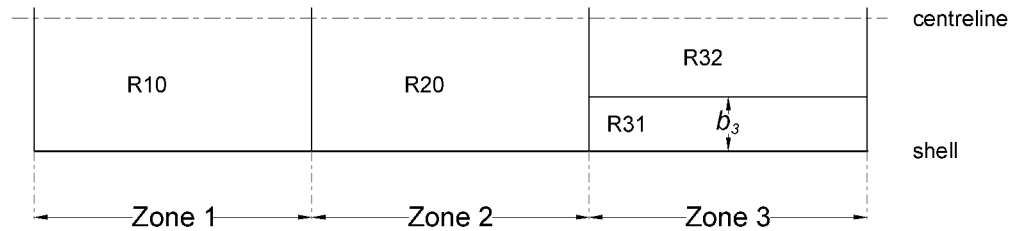

Figure: Combined damage of zones 1 + 2 + 3 includes a limited penetration to b_3 , taken into account generating two damages:

- 1) to b_3 with R10, R20 and R31 damaged;
- 2) to $B/2$ with R10, R20, R31 and R32 damaged.

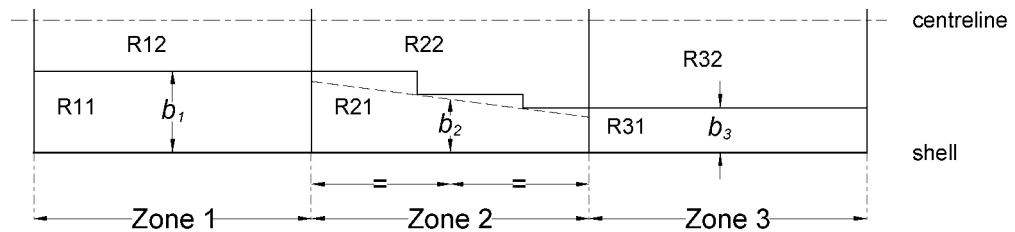

Figure: Combined damage of zones 1 + 2 + 3 includes 3 different limited damage penetrations generating four damages:

- 1) to b_3 with R11, R21 and R31 damaged;
- 2) to b_2 with R11, R21, R31 and R32 damaged;
- 3) to b_1 with R11, R21, R31, R32, and R22 damaged;
- 4) to $B/2$ with R11, R21, R31, R32, R22 and R12 damaged.

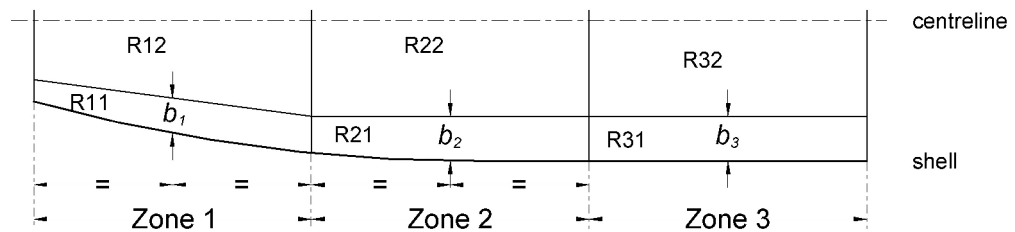
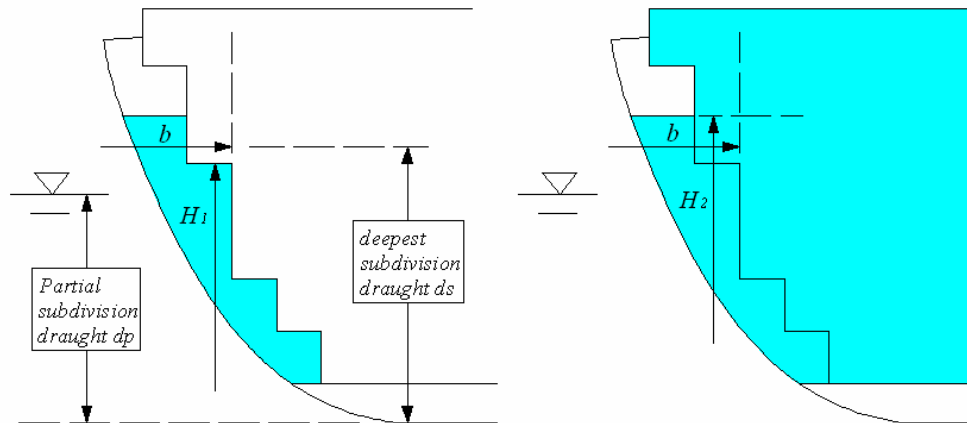

Figure: Combined damage of zone 1 + 2 + 3 including 2 different limited damage penetrations ($b_1 < b_2 = b_3$) generating three damages:

- 1) to b_1 with R11, R21 and R31 damaged;
- 2) to b_2 with R11, R21, R31 and R12, damaged;
- 3) to $B/2$ with R11, R21, R31, R12, R22 and R32 damaged.

10 A damage having a transverse extent b and a vertical extent H_2 leads to the flooding of both wing compartment and hold; for b and H_1 only the wing compartment is flooded. The figure below illustrates a partial subdivision draught d_p damage.



11 The same is valid if b -values are calculated for arrangements with sloped walls.

12 Pipes and valves directly adjacent to a longitudinal bulkhead can be considered to be part of the bulkhead, provided the separation distance is of the same order as the bulkhead stiffening structure. The same applies for small recesses, drain wells, etc.

REGULATION 7-2 – CALCULATION OF THE FACTOR s_i

General

1 Initial condition – an intact loading condition to be considered in the damage analysis described by the mean draught, vertical centre of gravity and the trim; or alternative parameters from where the same may be determined (ex. displacement, GM and trim). There are three initial conditions corresponding to the three draughts d_s , d_p and d_l .

2 Immersion limits – immersion limits are an array of points that are not to be immersed at various stages of flooding as indicated in regulations 7-2.5.2 and 7-2.5.3.

3 Openings – all openings need to be defined: both weathertight and unprotected. Openings are the most critical factor to preventing an inaccurate index A . If the final waterline immerses the lower edge of any opening through which progressive flooding takes place, the factor “ s ” may be recalculated taking such flooding into account. However, in this case the s value should also be calculated without taking into account progressive flooding and corresponding opening. The smallest s value should be retained for the contribution to the attained index.

Regulation 7-2.1

1 In cases where the GZ curve may include more than one “range” of positive righting levers for a specific stage of flooding, only one continuous positive “range” of the GZ curve may be used within the allowable range/heel limits for calculation purposes. Different stages of flooding may not be combined in a single GZ curve.

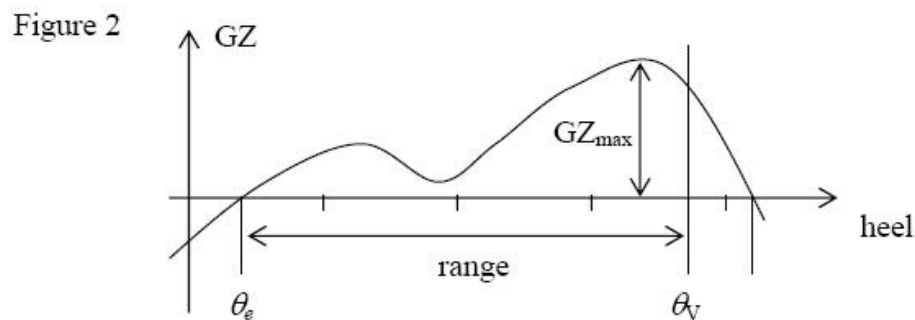
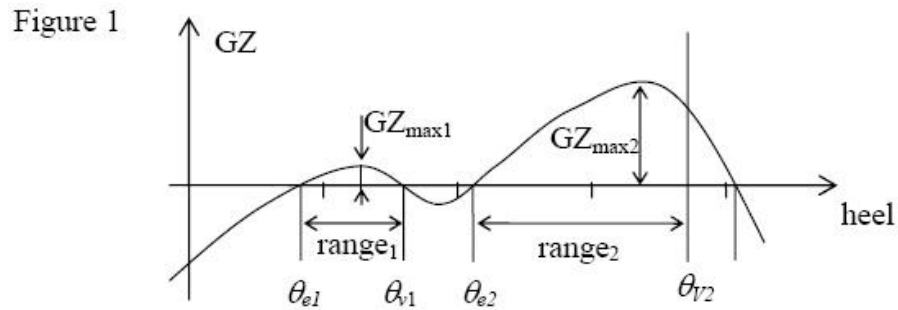

2 In figure 1, the s -factor may be calculated from the heel angle, range and corresponding GZ_{max} of the first or second “range” of positive righting levers. In figure 2, only one s -factor can be calculated.

Regulation 7-2.2

Intermediate stages of flooding

1 The case of instantaneous flooding in unrestricted spaces in way of the damage zone does not require intermediate stage flooding calculations. Where intermediate stages of flooding calculations are necessary in connection with progressive flooding, they should reflect the sequence of filling as well as filling level phases. Calculations for intermediate stages of flooding should be performed whenever equalization is not instantaneous, i.e. equalization is of a duration greater than 60 s. Such calculations consider the progress through one or more floodable (non-watertight) spaces. Bulkheads surrounding refrigerated spaces, incinerator rooms and longitudinal bulkheads fitted with non-watertight doors are typical examples of structures that may significantly slow down the equalization of main compartments.

Flooding boundaries

2 If a compartment contains decks, inner bulkheads, structural elements and doors of sufficient tightness and strength to seriously restrict the flow of water, for intermediate stage flooding calculation purposes it should be divided into corresponding non-watertight spaces. It is assumed that the non-watertight divisions considered in the calculations are limited to “A” class fire-rated bulkheads and do not apply to “B” class fire-rated bulkheads normally used in accommodation areas (e.g., cabins and corridors). This guidance also relates to regulation 4.4.

Sequential flooding computation

3 For each damage scenario, the damage extent and location determine the initial stage of flooding. Calculations should be performed in stages, each stage comprising of at least two intermediate filling phases in addition to the full phase per flooded space. Unrestricted spaces in way of damage should be considered as flooded immediately. Every subsequent stage involves all connected spaces being flooded simultaneously until an impermeable boundary or final equilibrium is reached. If due to the configuration of the subdivision in the ship it is expected that other intermediate stages of flooding are more onerous, then those should be investigated.

Cross-flooding/equalization

4 In general, cross-flooding is meant as a flooding of an undamaged space on the other side of the ship to reduce the heel in the final equilibrium condition.

5 The cross-flooding time should be calculated in accordance with the Recommendation on a standard method for evaluating cross-flooding arrangements (resolution MSC.245(83)). If complete fluid equalization occurs in 60 s or less, it should be treated as instantaneous and no further calculations need to be carried out. Additionally, in cases where $s_{final} = 1$ is achieved in 60 s or less, but equalization is not complete, instantaneous flooding may also be assumed if s_{final} will not become reduced. In any cases where complete fluid equalization exceeds 60 s, the value of $s_{intermediate}$ after 60 s is the first intermediate stage to be considered. Only passive open cross-flooding arrangements without valves should be considered effective for instantaneous flooding cases.

6 If complete fluid equalization can be finalized in 10 min or less, the assessment of survivability can be carried out for passenger ships as the smallest values of $s_{intermediate}$ or s_{final} .

7 In case the equalization time is longer than 10 min, s_{final} is calculated for the floating position achieved after 10 min of equalization. This floating position is computed by calculating the amount of flood water according to resolution MSC.245(83) using interpolation, where the equalization time is set to 10 min, i.e. the interpolation of the flood water volume is made between the case before equalization ($T = 0$) and the total calculated equalization time.

8 In any cases where complete fluid equalization exceeds 10 min, the value of s_{final} used in the formula in regulation 7-2.1.1 should be the minimum of s_{final} at 10 min or at final equalization.

Cargo ships

9 If the Administration considers that the stability in intermediate stages of flooding in a cargo ship may be insufficient, it may require further investigation thereof.

Regulation 7-2.4

The displacement is the intact displacement at the subdivision draught in question (d_s , d_p and d_l).

Regulation 7-2.4.1.1

The beam B used in this paragraph means breadth as defined in regulation 2.8.

Regulation 7-2.4.1.2

The parameter *A* (projected lateral area) used in this paragraph does not refer to the attained subdivision index.

Regulation 7-2.5

In cargo ships where cross-flooding devices are fitted, the safety of the ship should be maintained in all stages of flooding. The Administration may request for this to be demonstrated. Cross-flooding equipment, if installed, should have the capacity to ensure that the equalization takes place within 10 min.

Regulation 7-2.5.2.1

Unprotected openings

1 The flooding angle will be limited by immersion of such an opening. It is not necessary to define a criterion for non-immersion of unprotected openings at equilibrium, because if it is immersed, the range of positive *GZ* limited to flooding angle will be zero so “*s*” will be equal to zero.

2 An unprotected opening connects two rooms or one room and the outside. An unprotected opening will not be taken into account if the two connected rooms are flooded or none of these rooms are flooded. If the opening is connected to the outside, it will not be taken into account if the connected compartment is flooded. An unprotected opening does not need to be taken into account if it connects a flooded room or the outside to an undamaged room, if this room will be considered as flooded in a subsequent stage.

Openings fitted with a weathertight mean of closing (“weathertight openings”)

3 The survival “*s*” factor will be “0” if any such point is submerged at a stage which is considered as “final”. Such points may be submerged during a stage or phase which is considered as “intermediate”, or within the range beyond equilibrium.

4 If an opening fitted with a weathertight means of closure is submerged at equilibrium during a stage considered as intermediate, it should be demonstrated that this weathertight means of closure can sustain the corresponding head of water and that the leakage rate is negligible.

5 These points are also defined as connecting two rooms or one room and the outside, and the same principle as for unprotected openings is applied to take them into account or not. If several stages have to be considered as “final”, a “weathertight opening” does not need to be taken into account if it connects a flooded room or the outside to an undamaged room if this room will be considered as flooded in a successive “final” stage.

Regulation 7-2.5.2.2

1 Partial immersion of the bulkhead deck may be accepted at final equilibrium. This provision is intended to ensure that evacuation along the bulkhead deck to the vertical escapes will not be impeded by water on that deck. A “horizontal evacuation route” in the context of this regulation means a route on the bulkhead deck connecting spaces located on and under this deck with the vertical escapes from the bulkhead deck required for compliance with SOLAS chapter II-2.

2 Horizontal evacuation routes on the bulkhead deck include only escape routes (designated as category 2 stairway spaces according to SOLAS regulation II-2/9.2.2.3 or as category 4 stairway spaces according to SOLAS regulation II-2/9.2.2.4 for passenger ships carrying not more than 36 passengers) used for the evacuation of undamaged spaces. Horizontal evacuation routes do not include corridors (designated as category 3 corridor spaces according to SOLAS regulation II-2/9.2.2.3 or as category 2 corridor spaces according to SOLAS regulation II-2/9.2.2.4 for passenger ships carrying not more than 36 passengers) within the damaged space. No part of a horizontal evacuation route serving undamaged spaces should be immersed.

3 $s_i = 0$ where it is not possible to access a stair leading up to the embarkation deck from an undamaged space as a result of flooding to the “stairway” or “horizontal stairway” on the bulkhead deck.

4 Horizontal escapes situated in way of the damage extent may remain effective, therefore s_i need not be taken as zero. Contributions to the attained index A may still be gained.

Regulation 7-2.5.3.1

1 The purpose of this paragraph is to provide an incentive to ensure that evacuation through a vertical escape will not be obstructed by water from above. The paragraph is intended for smaller emergency escapes, typically hatches, where fitting of a watertight or weathertight means of closure would otherwise exclude them from being considered as flooding points.

2 Since the probabilistic regulations do not require that the watertight bulkheads be carried continuously up to the bulkhead deck, care should be taken to ensure that evacuation from intact spaces through flooded spaces below the bulkhead deck will remain possible, for instance by means of a watertight trunk.

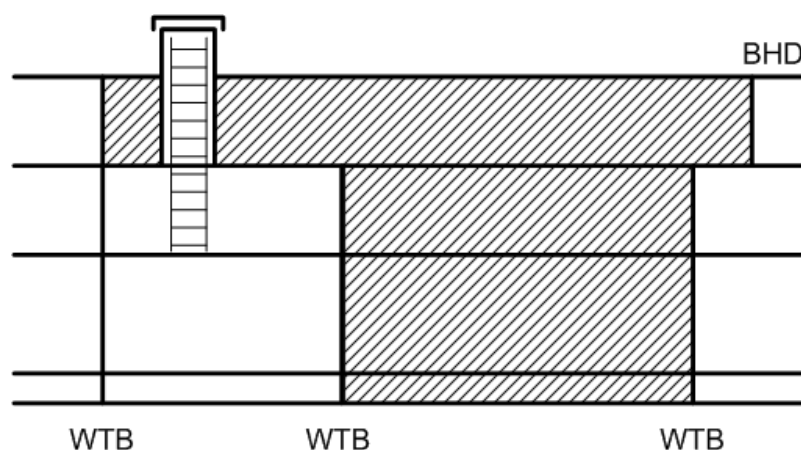

Regulation 7-2.6

The sketches in the figure illustrate the connection between position of watertight decks in the reserve buoyancy area and the use of factor v for damages below these decks.

<p>Above the waterline</p> <p>Below the waterline</p>	<p>In this example, there are 3 horizontal subdivisions to be taken into account as the vertical extent of damage.</p> <p>The example shows the maximum possible vertical extent of damage $d + 12.5$ m is positioned between H_2 and H_3. H_1 with factor v_1, H_2 with factor $v_2 > v_1$ but $v_2 < 1$ and H_3 with factor $v_3 = 1$.</p> <p>The factors v_1 and v_2 are the same as above. The reserve buoyancy above H_3 should be taken undamaged in all damage cases.</p> <p>The combination of damages into the rooms R1, R2 and R3 positioned below the initial water line should be chosen so that the damage with the lowest s-factor is taken into account. That often results in the definition of alternative damages to be calculated and compared. If the deck taken as lower limit of damage is not watertight, down flooding should be considered.</p>
---	--

Regulation 7-2.6.1

The parameters x_1 and x_2 are the same as parameters x_1 and x_2 used in regulation 7-1.

REGULATION 7-3 – PERMEABILITY**Regulation 7-3.2**

1 The following additional cargo permeabilities may be used:

Spaces	Permeability at draught d_s	Permeability at draught d_p	Permeability at draught d_l
Timber cargo in holds	0.35	0.7	0.95
Wood chip cargo	0.6	0.7	0.95

2 Reference is made to MSC/Circ.998 (IACS Unified Interpretation regarding timber deck cargo in the context of damage stability requirements) regarding timber deck cargo.

Regulation 7-3.3

1 Concerning the use of other figures for permeability “if substantiated by calculations”, such permeabilities should reflect the general conditions of the ship throughout its service life rather than specific loading conditions.

2 This paragraph allows for the recalculation of permeabilities. This should only be considered in cases where it is evident that there is a major discrepancy between the values shown in the regulation and the real values. It is not designed for improving the attained value of a deficient ship of regular type by the modification of chosen spaces in the ship that are known to provide significantly onerous results. All proposals should be considered on a case-by-case basis by the Administration and should be justified with adequate calculations and arguments.

REGULATION 8 – SPECIAL REQUIREMENTS CONCERNING PASSENGER SHIP STABILITY

Regulations 8.3.2 to 8.3.5

The number of persons carried, which is specified in these paragraphs, equals the total number of persons the ship is permitted to carry (and not $N = N_1 + 2 N_2$ as defined in regulation 6).

REGULATION 8-1 – SYSTEM CAPABILITIES AFTER A FLOODING CASUALTY ON PASSENGER SHIPS

Regulation 8-1.2

1 In the context of this regulation, “compartment” has the same meaning as defined under regulation 7-1 of these Explanatory Notes (i.e. an onboard space within watertight boundaries).

2 The purpose of the paragraph is to prevent any flooding of limited extent from immobilizing the ship. This principle should be applied regardless of how the flooding might occur. Only flooding below the bulkhead deck need be considered.

REGULATION 9 – DOUBLE BOTTOMS IN PASSENGER SHIPS AND CARGO SHIPS OTHER THAN TANKERS

Regulation 9.1

1 This regulation is intended to minimize the impact of flooding from a minor grounding. Special attention should be paid to the vulnerable area at the turn of the bilge. When justifying a deviation from fitting an inner bottom an assessment of the consequences of allowing a more extensive flooding than reflected in the regulation should be provided.

2 Except as provided in regulations 9.3 and 9.4, parts of the double bottom not extended for the full width of the ship as required by regulation 9.1 should be considered an unusual arrangement for the purpose of this regulation and should be handled in accordance with regulation 9.7.

Regulation 9.2

If an inner bottom is located higher than the partial subdivision draught d_p , this should be considered an unusual arrangement and should be handled in accordance with regulation 9.7.

Regulation 9.6

1 Any part of a passenger ship or a cargo ship where a double bottom is omitted in accordance with regulation 9.1, 9.4 or 9.5 shall be capable of withstanding bottom damages, as specified in regulation 9.8. The intent of this provision is to specify the circumstances under which the Administration should require calculations, which damage extents to assume and what survival criteria to apply when double bottoms are not fitted.

2 The definition of “watertight” in regulation 2.17 implies that the strength of inner bottoms and other boundaries assumed to be watertight should be verified if they are to be considered effective in this context.

Regulation 9.7

The reference to a “plane” in regulation 9.2 does not imply that the surface of the inner bottom may not be stepped in the vertical direction. Minor steps and recesses need not be considered unusual arrangements for the purpose of this paragraph as long as no part of the inner bottom is located below the reference plane. Discontinuities in way of wing tanks are covered by regulation 9.4.

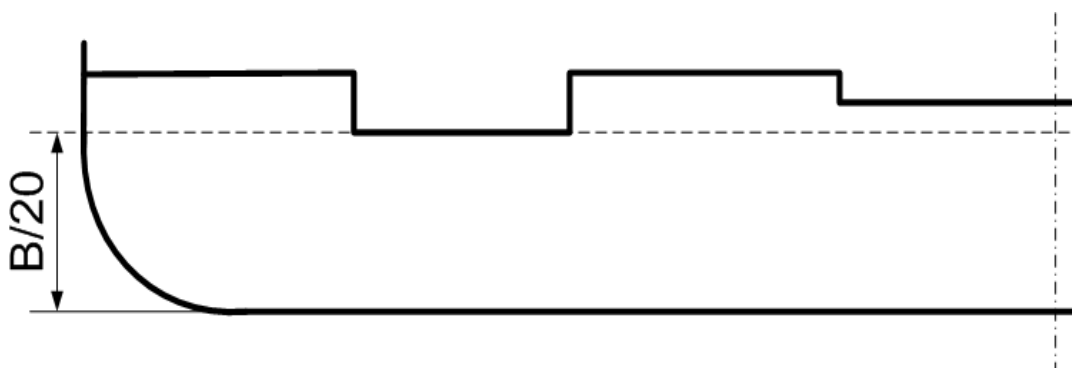
**Regulation 9.8**

1 The term “all service conditions” used in this paragraph means the three loading conditions used to calculate the attained subdivision index A .

2 The damage extents specified in this paragraph should be applied to all parts of the ship where no double bottom is fitted, as permitted by regulations 9.1, 9.4 or 9.5, and include any adjacent spaces located within the extent of damage. Small wells in accordance with regulation 9.3 do not need to be considered damaged even if within the extent of the damage. Possible positions of the damages are shown in an example below (parts of the ship not fitted with a double bottom are shaded; the damages to be assumed are indicated by boxes).

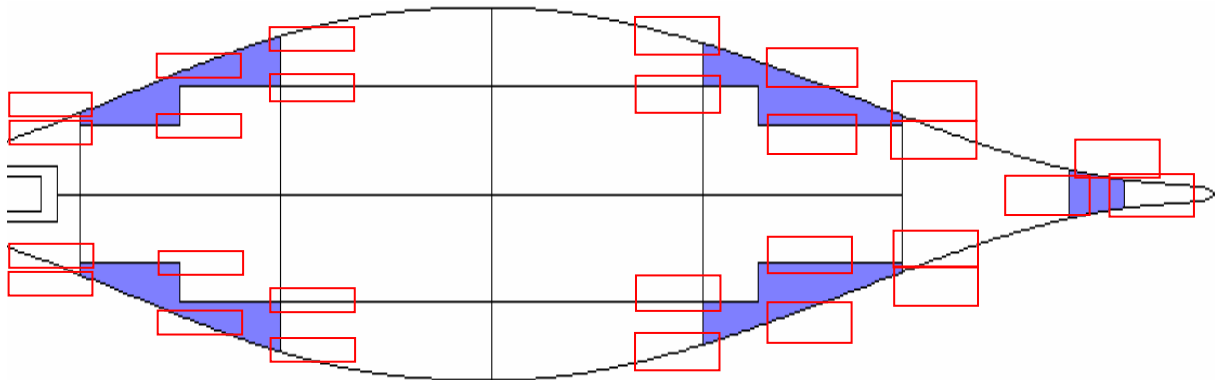

Regulation 9.9

1 For the purpose of identifying “large lower holds”, horizontal surfaces having a continuous deck area greater than approximately 30% in comparison with the waterplane area at subdivision draught should be taken to be located anywhere in the affected area of the ship. For the alternative bottom damage calculation, a vertical extent of $B/10$ or 3 m, whichever is less, should be assumed.

2 The increased minimum double bottom height of not more than $B/10$ or 3 m, whichever is less, for passenger ships with large lower holds, is applicable to holds in direct contact with the double bottom. Typical arrangements of ro-ro passenger ships may include a large lower hold with additional tanks between the double bottom and the lower hold, as shown in the figure below. In such cases, the vertical position of the double bottom required to be $B/10$ or 3 m, whichever is less, should be applied to the lower hold deck, maintaining the required double bottom height of $B/20$ or 2 m, whichever is less (but not less than 760 mm). The figure below shows a typical arrangement of a modern ro-ro passenger ferry.

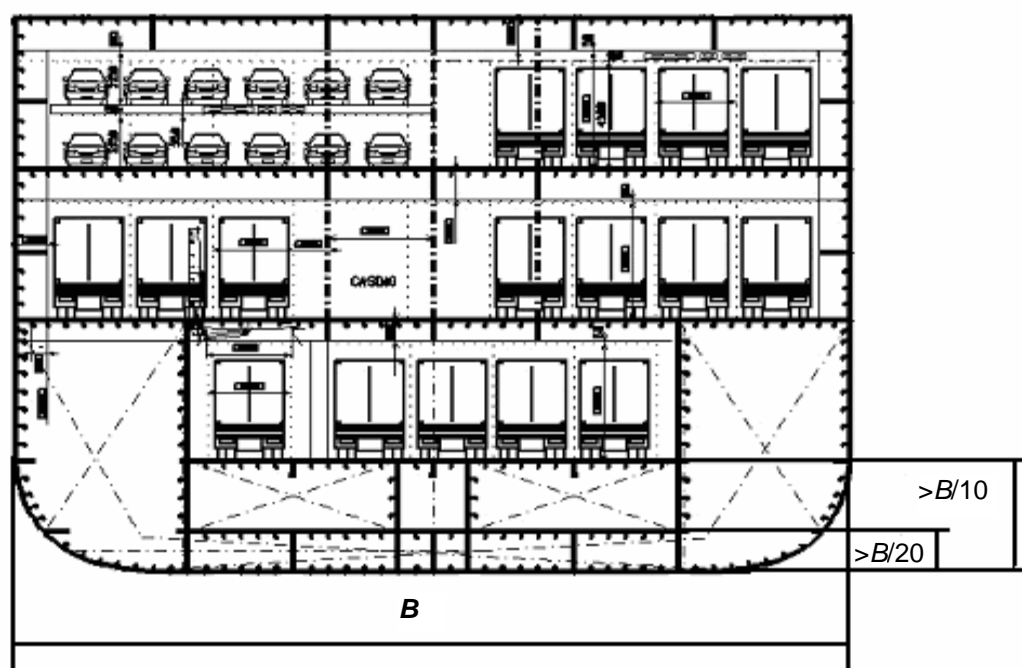

REGULATION 10 – CONSTRUCTION OF WATERTIGHT BULKHEADS

Regulation 10.1

For the treatment of steps in the bulkhead deck of passenger ships see Explanatory Notes for regulation 13. For the treatment of steps in the freeboard deck of cargo ships see Explanatory Notes for regulation 13-1.

REGULATION 12 – PEAK AND MACHINERY SPACE BULKHEADS, SHAFT TUNNELS, ETC.

Reference is made to MSC.1/Circ.1211 (Unified interpretations to SOLAS regulation II-1/10 and regulation 12 of the revised SOLAS chapter II-1 regarding bow doors and the extension of the collision bulkhead) concerning interpretations regarding bow doors and the extension of the collision bulkhead.

REGULATION 13 – OPENINGS IN WATERTIGHT BULKHEADS BELOW THE BULKHEAD DECK IN PASSENGER SHIPS

General – Steps in the bulkhead deck

1 If the transverse watertight bulkheads in a region of the ship are carried to a higher deck which forms a vertical step in the bulkhead deck, openings located in the bulkhead at the step may be considered as being located above the bulkhead deck. Such openings should then comply with regulation 17 and should be taken into account when applying regulation 7-2.

2 All openings in the shell plating below the upper deck throughout that region of the ship should be treated as being below the bulkhead deck and the provisions of regulation 15 should be applied. See figure below.

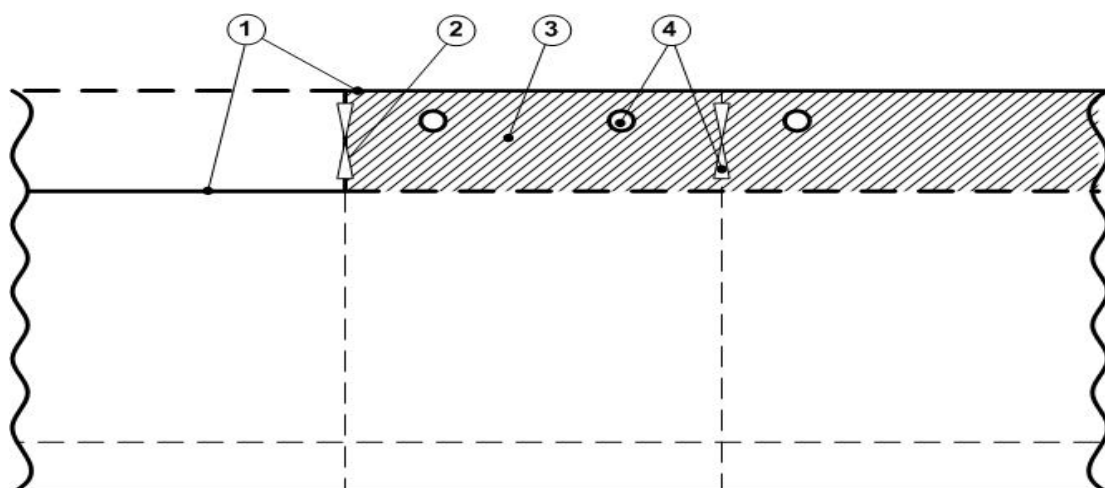

- | | |
|-----------------|---|
| 1 Bulkhead deck | 2 Considered as located above the bulkhead deck |
| 3 Ship's side | 4 Considered as located below the bulkhead deck |

Regulation 13.4

In cases where main and auxiliary propulsion machinery spaces, including boilers serving the needs for propulsion, are divided by watertight longitudinal bulkheads in order to comply with redundancy requirements (e.g., according to regulation 8-1.2), one watertight door in each watertight bulkhead may be permitted, as shown in the figure below.

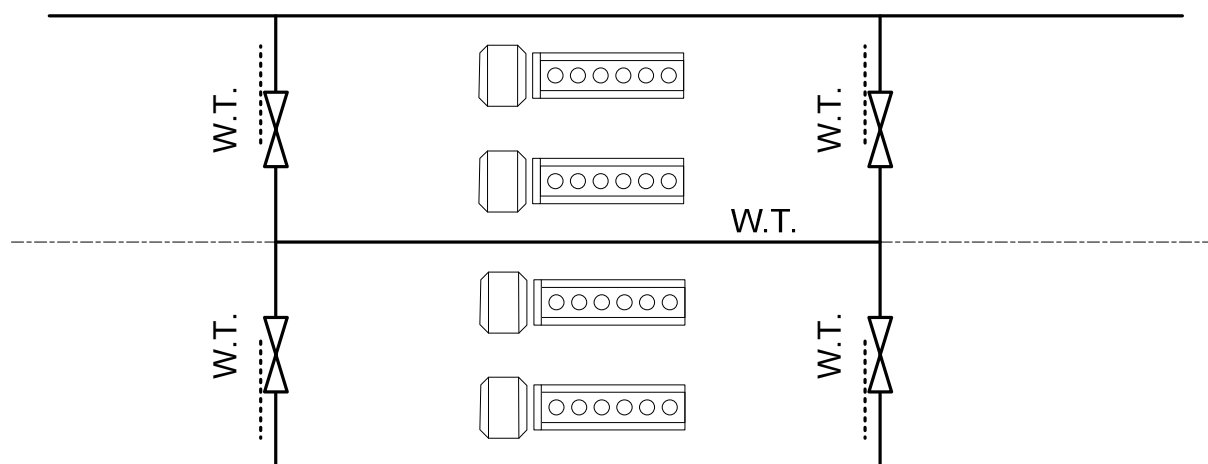

Regulation 13.7.6

The IEC standard referenced in the footnote (IEC publication 529, 1976) has been replaced by the newer standard IEC 60529:2003.

REGULATION 13-1 – OPENINGS IN WATERTIGHT BULKHEADS AND INTERNAL DECKS IN CARGO SHIPS

Regulation 13-1.1

1 If the transverse watertight bulkheads in a region of the ship are carried to a higher deck than in the remainder of the ship, openings located in the bulkhead at the step may be considered as being located above the freeboard deck.

2 All openings in the shell plating below the upper deck throughout that region of the ship should be treated as being below the freeboard deck, similar to the bulkhead deck for passenger ships (see relevant figure under regulation 13 above), and the provisions of regulation 15 should be applied.

REGULATION 15 – OPENINGS IN THE SHELL PLATING BELOW THE BULKHEAD DECK OF PASSENGER SHIPS AND THE FREEBOARD DECK OF CARGO SHIPS

General – Steps in the bulkhead deck and freeboard deck

For the treatment of steps in the bulkhead deck of passenger ships see Explanatory Notes for regulation 13. For the treatment of steps in the freeboard deck of cargo ships see Explanatory Notes for regulation 13-1.

REGULATION 15-1– EXTERNAL OPENINGS IN CARGO SHIPS

Regulation 15-1.1

With regard to air-pipe closing devices, they should be considered weathertight closing devices (not watertight). This is consistent with their treatment in regulation 7-2.5.2.1. However, in the context of regulation 15-1, “external openings” are not intended to include air-pipe openings.

REGULATION 16 – CONSTRUCTION AND INITIAL TESTS OF WATERTIGHT DOORS, SIDESCUTTLES, ETC.

Regulation 16.2

1 Watertight doors should be tested by water pressure to a head of water measured from the lower edge of the door opening to the bulkhead deck or the freeboard deck, or to the most unfavourable final or intermediate waterplane during flooding, whichever is greater.

2 Large doors, hatches or ramps on passenger and cargo ships, of a design and size that would make pressure testing impracticable, may be exempted from regulation 16.2, provided it is demonstrated by calculations that the doors, hatches or ramps maintain watertightness at design pressure with a proper margin of resistance. Where such doors utilize gasket seals, a prototype pressure test to confirm that the compression of the gasket material is capable of accommodating any deflection, revealed by the structural analysis, should be carried out. After installation every such door, hatch or ramp should be tested by means of a hose test or equivalent.

Note: See Explanatory Notes for regulation 13 for additional information regarding the treatment of steps in the bulkhead deck of passenger ships. See Explanatory Notes for regulation 13-1 for additional information regarding the treatment of steps in the freeboard deck of cargo ships.

REGULATION 17 – INTERNAL WATERTIGHT INTEGRITY OF PASSENGER SHIPS ABOVE THE BULKHEAD DECK

General – Steps in the bulkhead deck

For the treatment of steps in the bulkhead deck of passenger ships see Explanatory Notes for regulation 13.

Regulation 17.1

Watertight sliding doors with reduced pressure head complying with the requirements of MSC/Circ.541, as may be amended, should be in line with regulation 7-2.5.2.1. These types of tested watertight sliding doors with reduced pressure head could be immersed during intermediate stages of flooding.

Regulation 17.3

These provisions regarding the open end of air pipes should be applied only to damages of longitudinal and transverse extent as defined in regulation 8.3 but limited to the bulkhead deck and involving tanks having their open end terminating within the superstructure.

APPENDIX

GUIDELINES FOR THE PREPARATION OF SUBDIVISION AND DAMAGE STABILITY CALCULATIONS

1 GENERAL

1.1 Purpose of the Guidelines

1.1.1 These Guidelines serve the purpose of simplifying the process of the damage stability analysis, as experience has shown that a systematic and complete presentation of the particulars results in considerable saving of time during the approval process.

1.1.2 A damage stability analysis serves the purpose to provide proof of the damage stability standard required for the respective ship type. At present, two different calculation methods, the deterministic concept and the probabilistic concept are applied.

1.2 Scope of analysis and documentation on board

1.2.1 The scope of subdivision and damage stability analysis is determined by the required damage stability standard and aims at providing the ship's master with clear intact stability requirements. In general, this is achieved by determining *KG*-respective *GM*-limit curves, containing the admissible stability values for the draught range to be covered.

1.2.2 Within the scope of the analysis thus defined, all potential or necessary damage conditions will be determined, taking into account the damage stability criteria, in order to obtain the required damage stability standard. Depending on the type and size of ship, this may involve a considerable amount of analyses.

1.2.3 Referring to SOLAS chapter II-1, regulation 19, the necessity to provide the crew with the relevant information regarding the subdivision of the ship is expressed, therefore plans should be provided and permanently exhibited for the guidance of the officer in charge. These plans should clearly show for each deck and hold the boundaries of the watertight compartments, the openings therein with means of closure and position of any controls thereof, and the arrangements for the correction of any list due to flooding. In addition, Damage Control Booklets containing the aforementioned information should be available.

2 DOCUMENTS FOR SUBMISSION

2.1 Presentation of documents

The documentation should begin with the following details: principal dimensions, ship type, designation of intact conditions, designation of damage conditions and pertinent damaged compartments, *KG*-respective *GM*-limit curve.

2.2 General documents

For the checking of the input data, the following should be submitted:

- .1 main dimensions;
- .2 lines plan, plotted or numerically;

- .3 hydrostatic data and cross curves of stability (including drawing of the buoyant hull);
- .4 definition of sub-compartments with moulded volumes, centres of gravity and permeability;
- .5 layout plan (watertight integrity plan) for the sub-compartments with all internal and external opening points including their connected sub-compartments, and particulars used in measuring the spaces, such as general arrangement plan and tank plan. The subdivision limits, longitudinal, transverse and vertical, should be included;
- .6 light service condition;
- .7 load line draught;
- .8 coordinates of opening points with their level of tightness (e.g., weathertight, unprotected);
- .9 watertight door location with pressure calculation;
- .10 side contour and wind profile;
- .11 cross and down flooding devices and the calculations thereof according to resolution MSC.245(83) with information about diameter, valves, pipe lengths and coordinates of inlet/outlet;
- .12 pipes in damaged area when the destruction of these pipes results in progressive flooding; and
- .13 damage extensions and definition of damage cases.

2.3 Special documents

The following documentation of results should be submitted.

2.3.1 Documentation

2.3.1.1 Initial data:

- .1 subdivision length L_s ;
- .2 initial draughts and the corresponding GM -values;
- .3 required subdivision index R ; and
- .4 attained subdivision index A with a summary table for all contributions for all damaged zones.

2.3.1.2 Results for each damage case which contributes to the index A :

- .1 draught, trim, heel, GM in damaged condition;

- .2 dimension of the damage with probabilistic values p , v and r ;
- .3 righting lever curve (including GZ_{max} and range) with factor of survivability s ;
- .4 critical weathertight and unprotected openings with their angle of immersion; and
- .5 details of sub-compartments with amount of in-flooded water/lost buoyancy with their centres of gravity.

2.3.1.3 In addition to the requirements in paragraph 2.3.1.2, particulars of non-contributing damages ($s_i = 0$ and $p_i > 0.00$) should also be submitted for passenger ships and ro-ro ships fitted with long lower holds including full details of the calculated factors.

2.3.2 Special consideration

For intermediate conditions, as stages before cross-flooding or before progressive flooding, an appropriate scope of the documentation covering the aforementioned items is needed in addition.
